

Data sheet | Item number: 261-204/332-000

4-conductor terminal strip; 4-pole; on one side with push-buttons; with fixing flanges; for screw or similar mounting types; Fixing hole 3.2 mm Ø; 2.5 mm²; CAGE CLAMP®

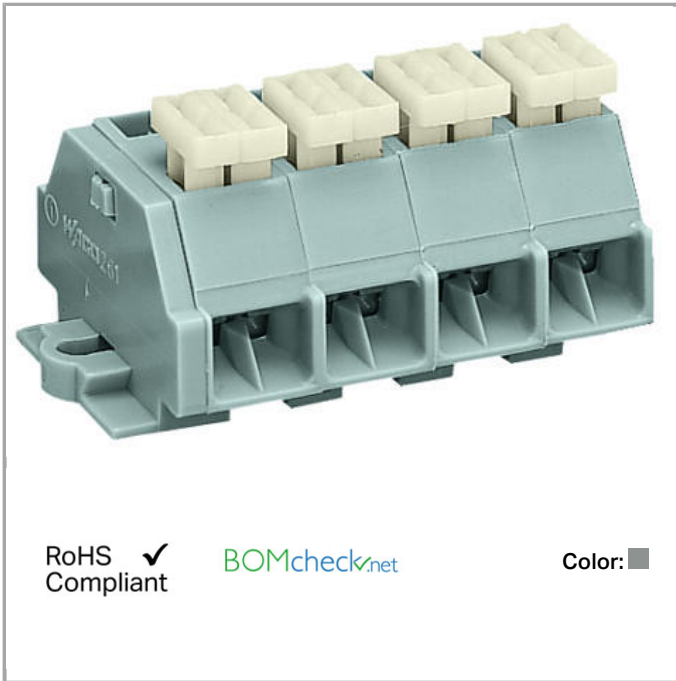

261-204/332-000



RoHS Compliant

[BOMcheck.net](https://www.bomcheck.net)

Color:

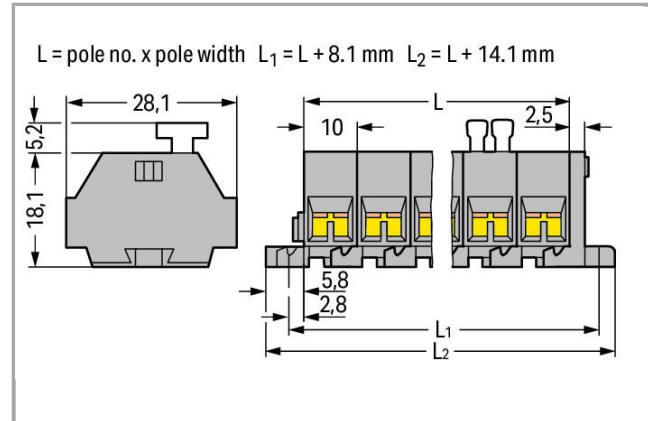

Data

Electrical data

Ratings per IEC/EN 60664-1

Rated voltage (III / 3)	500 V
Rated impulse voltage (III / 3)	6 kV
Rated current	24 A

Connection data

Connection technology	CAGE CLAMP®
Actuation type	Operating tool Push-button
Connectable conductor materials	Copper
Solid conductor	0.08 ... 2.5 mm ² / 28 ... 14 AWG
Fine-stranded conductor	0.08 ... 2.5 mm ² / 28 ... 14 AWG
Strip length	8 ... 9 mm / 0.31 ... 0.35 inch
No. of poles	4
Total number of connection points	16
Total number of potentials	4

Number of levels	1
Type of wiring	Side-entry wiring

Geometrical Data

Width	54.5 mm / 2.146 inch
Height from the surface	23.2 mm / 0.913 inch
Depth	28 mm / 1.102 inch
Module width	10 mm / 0.394 inch

Mechanical data

Design	horizontal
Mounting type	Mounting flange
Marking level	Side marking

Material Data



Color	gray
Fire load	0.313 MJ
Weight	17.61 g

Commercial data

Country of origin	DE
GTIN	4044918612692
Customs Tariff No.	85369010000

Approvals / Certificates

Country specific Approvals

Logo	Approval	Additional Approval Text	Certificate name
	CCA DEKRA Certification B.V.	EN 60998	NTR-NL 6509
	CCA DEKRA Certification B.V.	EN 60998	2110272.02

Ship Approvals

Logo	Approval	Additional Approval Text	Certificate name
	ABS American Bureau of Shipping	-	14- HG1241539-



LR
Lloyds Register

91/20242
(E6)

Compatible products

assembling



Item no.: 209-137
Mounting adapter; can be used as end plate; 6.5 mm wide

209-137

ferrule



Item no.: 216-101
Ferrule; Sleeve for 0.5 mm² / AWG 22; uninsulated; electro-tin plated

216-101



Item no.: 216-102
Ferrule; Sleeve for 0.75 mm² / AWG 20; uninsulated; electro-tin plated

216-102



Item no.: 216-103
Ferrule; Sleeve for 1 mm² / AWG 18; uninsulated; electro-tin plated

216-103



Item no.: 216-104
Ferrule; Sleeve for 1.5 mm² / AWG 16; uninsulated; electro-tin plated

216-104



Item no.: 216-106
Ferrule; Sleeve for 2.5 mm² / AWG 14; uninsulated; electro-tin plated

216-106



Item no.: 216-121
Ferrule; Sleeve for 0.5 mm² / AWG 22; uninsulated; electro-tin plated

216-121



Item no.: 216-122
Ferrule; Sleeve for 0.75 mm² / AWG 20; uninsulated; electro-tin plated

216-122



Item no.: 216-123
Ferrule; Sleeve for 1 mm² / AWG 18; uninsulated; electro-tin plated

216-123



Item no.: 216-124
Ferrule; Sleeve for 1.5 mm² / AWG 16; uninsulated; electro-tin plated

216-124



















Item no.: 216-131
Ferrule; Sleeve for 0.25 mm² / AWG 24; uninsulated; electro-tin plated

216-131



Item no.: 216-132
Ferrule; Sleeve for 0.34 mm² / AWG 24; uninsulated; electro-tin plated

216-132

	Item no.: 216-151 Ferrule; Sleeve for 0.25 mm ² / AWG 24; uninsulated; electro-tin plated	216-151
	Item no.: 216-152 Ferrule; Sleeve for 0.34 mm ² / AWG 24; uninsulated; electro-tin plated	216-152
	Item no.: 216-201 Ferrule; Sleeve for 0.5 mm ² / 20 AWG; insulated; electro-tin plated	216-201
	Item no.: 216-202 Ferrule; Sleeve for 0.75 mm ² / 18 AWG; insulated; electro-tin plated	216-202
	Item no.: 216-203 Ferrule; Sleeve for 1 mm ² / AWG 18; insulated; electro-tin plated	216-203
	Item no.: 216-204 Ferrule; Sleeve for 1.5 mm ² / AWG 16; insulated; electro-tin plated	216-204
	Item no.: 216-205 Ferrule; Sleeve for 2.08 mm ² / AWG 14; insulated; electro-tin plated	216-205
	Item no.: 216-206 Ferrule; Sleeve for 2.5 mm ² / AWG 14; insulated; electro-tin plated	216-206
	Item no.: 216-221 Ferrule; Sleeve for 0.5 mm ² / 20 AWG; insulated; electro-tin plated	216-221
	Item no.: 216-222 Ferrule; Sleeve for 0.75 mm ² / 18 AWG; insulated; electro-tin plated	216-222
	Item no.: 216-223 Ferrule; Sleeve for 1 mm ² / AWG 18; insulated; electro-tin plated	216-223
	Item no.: 216-224 Ferrule; Sleeve for 1.5 mm ² / AWG 16; insulated; electro-tin plated	216-224
	Item no.: 216-301 Ferrule; Sleeve for 0.25 mm ² / AWG 24; insulated; electro-tin plated	216-301
	Item no.: 216-302 Ferrule; Sleeve for 0.34 mm ² / 22 AWG; insulated; electro-tin plated	216-302
	Item no.: 216-321 Ferrule; Sleeve for 0.25 mm ² / AWG 24; insulated; electro-tin plated	216-321
	Item no.: 216-322 Ferrule; Sleeve for 0.34 mm ² / 22 AWG; insulated; electro-tin plated	216-322
Jumper		
	Item no.: 261-402 Comb-style jumper bar; insulated; 2-way; reduces conductor size to 1.5 mm	261-402
tools		
	Item no.: 209-132 Operating tool; for connecting comb-style jumper bar; 2-way; of insulating material	209-132
	Item no.: 210-657 Operating tool with partially insulated shaft; Blade (3.5 x 0.5) mm; short	210-657



Item no.: 210-658

210-658

Operating tool with partially insulated shaft; Blade (3.5 x 0.5) mm; short; angled



Item no.: 210-720

210-720

Operating tool with partially insulated shaft; Type 2, blade (3.5 x 0.5) mm

General accessories



Item no.: 209-123

209-123

Mounting foot with screw; can be screwed on terminal blocks with fixing flange; 6.4 mm wide

Downloads

Documentation

Bid Text

261-204/332-000

doc
25.1 kB

Download

CAD/CAE - Smart Data

CAD data

3D Download 261-204/332-000

URL

Download

Subject to changes.